

PHILIPS

BT3232



© 2023 Koninklijke Philips N.V.
All rights reserved
Tous droits réservés
3000.125.8395.1 (27/07/2023)



>75 % recycled paper

>75 % papier recyclé

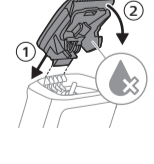
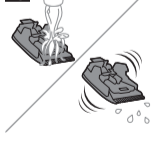
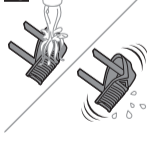
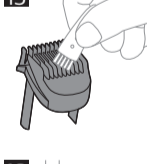
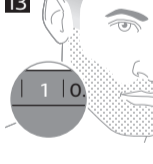
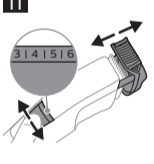
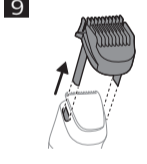
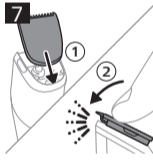
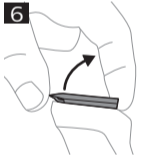
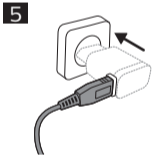
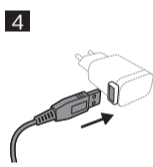

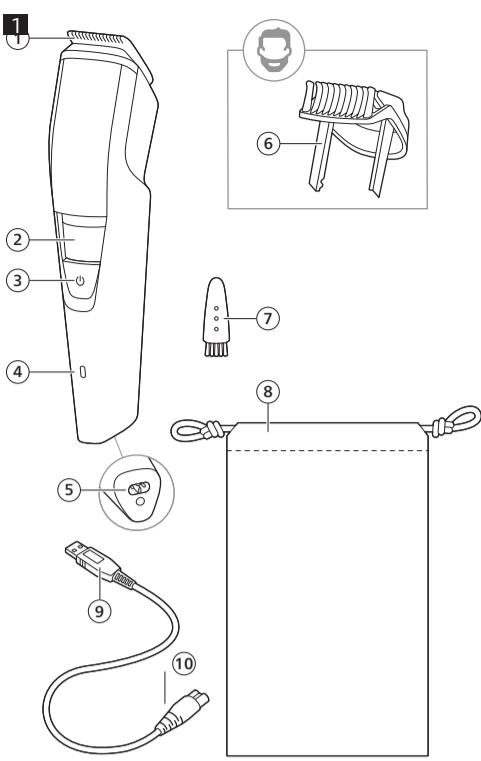

English

IMPORTANT SAFETY INSTRUCTIONS

When using an electric product, basic precautions should always be followed, including the following:

Read all instructions before using this product.

DANGER

To reduce the risk of electric shock:

- To charge the product, only use a USB power source on a certified product with output rating 5 V, ≥ 1 A. A suitable power source (e.g. Philips HQ87) is available via www.philips.com/support. If you need support finding the correct USB power source, contact Philips support at 1-866-800-9311. Using a non-certified USB power source may cause hazards or serious injuries.
- Keep the product, the USB cable and the USB power source dry.



- Use product only in dry condition. Do not use while bathing or in a shower.
- Do not reach for a corded product that has fallen into water. Unplug immediately from the power outlet.
- Do not place or store the product where it can fall or be pulled into a tub or sink. Do not place or drop the product into water or other liquid.
- This product does not work while it is connected to the power outlet. Except when charging, always unplug this product from the power outlet.
- Remove USB power source from power outlet and product before cleaning.
- Guards and cutting units can be rinsed under the tap if detached from the product.

WARNING

To reduce the risk of burns, fire, electric shock, or injury to persons:

- This product is not intended for use by persons (including children) with reduced physical, sensory or mental capabilities, or lack of experience and knowledge, unless they have been given supervision or instruction concerning use of the product by a person responsible for their safety. Children should be supervised to ensure that they do not play with the product.
- Use this product only for its intended household use as described in this manual. Misuse can lead to hazards or serious injuries. Do not use attachments not recommended by Philips Electronics Ltd (Canada).
- Never operate this product if it has a damaged USB power source, if it is not working properly, after it has been dropped or damaged, or after the product or the USB power source has been dropped into water. For assistance call 1-866-800-9311.
- Keep the USB cable and the USB power source away from heated surfaces.
- Never drop or insert any object into any opening.
- Do not use the power cord in or near a power outlet that contains an electric air freshener to prevent damage to the power cord.
- Do not use product outdoors or operate where aerosol (spray) products are being used or where oxygen is being administered.
- Always check cutting units and other attachments and accessories before you use the product. Never use the product with a damaged cutting unit, attachment or accessory, as injury may occur.
- Always attach the USB cable to the USB power source and the product first, then attach the USB power source to the power outlet. To disconnect, set all controls to 'off' position. Then remove the USB power source from the power outlet.
- Plug USB power source directly into power outlet. Do not use an extension cord.
- Unplug USB power source before plugging in or unplugging the product.
- The batteries used in this product may present a fire or chemical burn hazard if mistreated. Do not disassemble, heat above 100 °C (212 °F) or incinerate.
- Only use original Philips accessories or consumables.
- Charge, use and store the product at a temperature between 5 °C and 35 °C.

- Keep product and batteries away from fire and do not expose them to direct sunlight or high temperatures.
- If the product becomes abnormally hot or smelly, changes color or if charging takes longer than usual, stop using and charging the product and contact Philips.
- Do not place products and their batteries in microwave ovens or on induction cookers.
- Do not open, modify, pierce, damage or dismantle the product or battery to prevent batteries from heating up or releasing toxic or hazardous substances. Do not short-circuit, overcharge or reverse charge batteries.
- If batteries are damaged or leaking, avoid contact with the skin or eyes. If this occurs, immediately rinse well with water and seek medical care.
- When you handle batteries, make sure that your hands, the product and the batteries are dry.
- To avoid accidental short-circuiting of batteries after removal, do not let battery terminals come into contact with metal objects (e.g. coins, hairpins, rings). Do not wrap batteries in aluminum foil. Tape battery terminals or put batteries in a plastic bag before you discard them.

Electromagnetic fields (EMF)

This Philips appliance complies with all applicable standards and regulations regarding exposure to electromagnetic fields.

SAVE THESE INSTRUCTIONS

IMPORTANT INFORMATION

- This appliance can only be used without cord (Fig. 2).
- Because of hygiene, only one person should use the appliance.
- Switch off the appliance before removing or attaching attachments and before cleaning.
- Clean the appliance after each use (see 'Cleaning').
- Never use compressed air, scouring pads, abrasive cleaning agents or aggressive liquids such as gasoline or acetone to clean the appliance.
- Caution: Never dry the trimmer teeth with a towel or tissue, as this may damage the trimmer teeth.

Introduction

Congratulations on your purchase and welcome to Philips! To fully benefit from the support that Philips offers, register your product at www.philips.com/welcome.

You can find the model number on the back of your product.

The full model number (e.g. BT1234/56) is located on the bottom of the packaging, your receipt or order confirmation.

General description (Fig. 1)

- 1 Cutting element
- 2 Hair length setting wheel
- 3 On/off button
- 4 Battery status indicator
- 5 Socket for small plug
- 6 Trimming comb
- 7 Cleaning brush
- 8 Pouch
- 9 USB cable

Note: A suitable power source (e.g. Philips HQ87) is available via www.philips.com/support.

- 10 Small plug

Charging

- Charging or using the appliance at temperatures below 5 °C or higher than 35 °C adversely affects the lifespan of the battery.
- If the appliance is subjected to a major change in temperature, pressure or humidity, let the appliance acclimatize for 30 minutes before use.

Charge the appliance before first use and when the battery status indicator shows that the battery is almost empty. When the appliance has charged for 60 minutes, it has a cordless operating time of up to 90 minutes.

Warning: Keep the product, the USB cable and the USB power source dry



- 1 Make sure that the product is switched off.
- 2 Insert the small plug of the USB cable into the socket in the bottom of the product (Fig. 3).
- 3 Insert the USB plug into the USB power source (not included) (Fig. 4).
- 4 Insert the USB power source into the power outlet (Fig. 5).
- 5 After charging, remove the USB power source from the power outlet and pull the small plug out of the product.

Battery status indicator

Battery status	Indicator mode
Almost empty	Flashing orange light
Charging	Flashing white light
Fully charged	Solid white light

Note: Approx. 30 minutes after the battery is fully charged, the battery status indicator switches off automatically.

Quick charge

After approx. 5 minutes of charging, the appliance contains enough power for one cordless trimming session.

Optimizing the lifetime of the rechargeable battery

When you have charged the appliance for the first time, we advise you to use it until the battery is completely empty. Continue to use the appliance until the motor almost stops running during a session.

Then recharge the battery. Follow this procedure at least twice a year.

Using the appliance

Detaching and attaching the cutting element

- 1 To detach the cutting element, place your thumb near the teeth of the cutting element and push gently upwards until the cutting element is released from the handle (Fig. 6).
- 2 To attach the cutting element, insert the plastic notch at the back of the cutting element into the guiding slot in the handle and gently press the teeth of the cutting element downwards until the cutting element clicks into place (Fig. 7).

Attaching and detaching the trimming comb

- 1 To attach the trimming comb onto the appliance, slide the trimming comb straight into the guiding grooves of the appliance until the comb clicks into place (Fig. 8).
- 2 To detach the trimming comb from the appliance, hold the comb on both sides and gently pull it off the appliance (Fig. 9).

Switching the appliance on and off

To switch the appliance on or off, press the on/off button once (Fig. 10).

Trimming tips

- Always comb your beard or moustache with a fine comb before you start trimming.
- When trimming for the first time, start by using the comb with the maximum trimming length setting to familiarize yourself with the appliance.
- Since hairs do not all grow in the same direction, you may want to try different trimming positions (i.e. upwards, downwards, or across). Practice is best for optimum results.
- Always make smooth and gentle movements and be sure the surface of the comb always stays in contact with your skin.
- When too many hairs have accumulated on the appliance, remove the hairs before and/or during use, for best trimming results.

Trimming with comb

Use the trimming comb attached to the cutting element to trim your beard and mustache in your preferred style. Turn the hair length setting wheel to choose from 20 length settings ranging from 0.5 mm to 10 mm.

- 1 Attach the trimming comb to the appliance (see 'Attaching and detaching the trimming comb').
- 2 Turn the hair length setting wheel to select the desired hair length setting (Fig. 11). The settings on the wheel correspond to the remaining hair length after trimming. The selected hair length setting in millimeters is shown in the center of the wheel.
- 3 Switch the appliance on (see 'Switching the appliance on and off').
- 4 To trim in the most effective way, move the comb against the direction of hair growth (Fig. 12). Make sure that the surface of the comb always stays in contact with the skin.
- 5 Shake off cut hair from the comb every few strokes. If a lot of hair has accumulated in the comb, switch off the appliance, remove the comb and blow and/or shake off the hairs. The selected hair length setting does not change when the comb is removed.
- 6 Switch off and clean the appliance after each use (see 'Cleaning').

Trimming for 'stubble look'

Attach the trimming comb to the appliance and use the 1 mm setting to create a 'stubble look' trim (Fig. 13).

Trimming without comb

Use the trimmer without the trimming comb to trim hair close to the skin (to a length of approx. 0.5 mm) or to trim edges and single hairs.

- 1 Detach the trimming comb from the appliance (see 'Attaching and detaching the trimming comb').
- 2 Switch the appliance on (see 'Switching the appliance on and off').
- 3 To trim hair close to the skin, place the flat side of the cutting element against your skin and make strokes against the direction of hair growth.
- 4 For contouring, hold the cutting element perpendicular to the skin. Make well-controlled movements. Touch the hair lightly with the trimmer (Fig. 14).
- 5 Switch off and clean the appliance after each use (see 'Cleaning').

Cleaning

⚠ Never immerse the handle in water or rinse it under the tap. Only the cutting element and the trimming comb can be rinsed under the tap when detached from the handle.

- 1 Make sure that the appliance is switched off and that the USB power source has been removed from the power outlet and from the appliance.
- 2 Wipe the handle with a dry cloth.

Cleaning with brush

- 1 Detach the trimming comb from the appliance and clean it with the cleaning brush (Fig. 15).
- 2 Detach the cutting element from the appliance (see 'Detaching and attaching the cutting element'). Clean the cutting teeth and the inside of the cutting element with the cleaning brush (Fig. 16).
- 3 Clean the inside of the hair chamber with the cleaning brush (Fig. 17).

Cleaning attachments under the tap

Only use cold or lukewarm water to clean the cutting element or trimming comb.

- 1 Detach the trimming comb from the appliance and rinse the comb under the tap (Fig. 18).
- 2 Detach the cutting element from the appliance and rinse the cutting element under the tap (Fig. 19).

- Carefully shake off excess water and let both parts air-dry completely before reattaching them to the appliance (Fig. 20).

Storage

Note: Do not place or store the appliance where it can fall or be pulled into a tub or sink, water or other liquid while plugged in.

- Make sure that the appliance is switched off and that the USB power source has been removed from the power outlet and from the appliance.
- Do not wrap the USB cable around the appliance when storing.
- Store the appliance, the USB power source and all the accessories in the pouch supplied. Place the pouch in a safe, dry location, where it will not be crushed, banged, or subject to damage.
- Make sure that the appliance and the accessories are dry before you store them in the pouch.

Ordering accessories

To buy accessories or spare parts, visit www.philips.com/parts-and-accessories or go to your Philips dealer. You can also contact the Philips Consumer Care Center in your country (see the international warranty leaflet for contact details).

Disposal

- This product contains a rechargeable lithium-ion battery which must be disposed of properly.
- Contact your local town or city officials for battery disposal information. You can also call 1-888-224-9764 or visit www.call2recycle.ca for battery drop-off locations.
- For assistance, visit our website www.philips.com/support or call 1-866-800-9311 toll free.
- Your product is designed and manufactured with high quality materials and components, which can be recycled and reused. For recycling information, please contact your local waste management facilities or visit www.recycle.philips.com.

Support

For all product support such as frequently asked questions, please visit www.philips.com/support.

Full Two-Year Warranty

Philips Electronics Ltd warrants this new product against defects in materials or workmanship for a period of two years from the date of purchase, and agrees to repair or replace any defective product without charge.

IMPORTANT: This warranty does not cover damage resulting from accident, misuse or abuse, lack of reasonable care, the affixing of any attachment not provided with the product or loss of parts or subjecting the product to any but the specified voltage.*

NO RESPONSIBILITY IS ASSUMED FOR ANY SPECIAL, INCIDENTAL OR CONSEQUENTIAL DAMAGES.

Cutting units and combs are not covered by the terms of this warranty because they are subject to wear and tear.

In order to obtain warranty service, simply go to www.philips.com/support for assistance. It is suggested that for your protection you return shipments of product by insured mail, insurance prepaid. Damage occurring during shipment is not covered by this warranty. NOTE: No other warranty, written or oral, is authorized by Philips Electronics Ltd. This warranty gives you specific legal rights, and you may also have other rights which vary from state to state, province to province or country to country. Some states do not allow the exclusion or limitation of incidental or consequential damages, so the above exclusion and limitations may not apply to you.

*Read enclosed instructions carefully.